

EVALUATION KIT
AVAILABLE

MAXIM

300MHz to 450MHz High-Efficiency, Crystal-Based +13dBm ASK Transmitter

General Description

The MAX7044 crystal-referenced phase-locked-loop (PLL) VHF/UHF transmitter is designed to transmit OOK/ASK data in the 300MHz to 450MHz frequency range. The MAX7044 supports data rates up to 100kbps, and provides output power up to +13dBm into a 50Ω load while only drawing 7.7mA at 2.7V.

The crystal-based architecture of the MAX7044 eliminates many of the common problems with SAW-based transmitters by providing greater modulation depth, faster frequency settling, higher tolerance of the transmit frequency, and reduced temperature dependence. The MAX7044 also features a low supply voltage of +2.1V to +3.6V. These improvements enable better overall receiver performance when using the MAX7044 together with a superheterodyne receiver such as the MAX1470 or MAX1473.

A simple, single-input data interface and a buffered clock-out signal at 1/16th the crystal frequency make the MAX7044 compatible with almost any microcontroller or code-hopping generator.

The MAX7044 is available in an 8-pin SOT23 package and is specified over the -40°C to +125°C automotive temperature range.

Applications

- Remote Keyless Entry (RKE)
- Tire-Pressure Monitoring (TPM)
- Security Systems
- Garage Door Openers
- RF Remote Controls
- Wireless Game Consoles
- Wireless Computer Peripherals
- Wireless Sensors

Typical Application Circuit

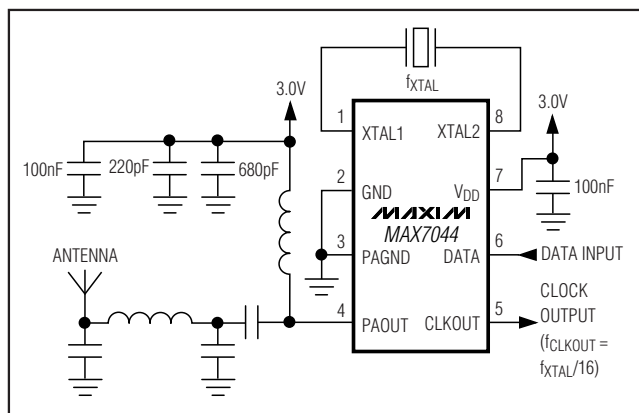

Features

- ◆ +2.1V to +3.6V Single-Supply Operation
- ◆ OOK/ASK Transmit Data Format
- ◆ Up to 100kbps Data Rate
- ◆ +13dBm Output Power into 50Ω Load
- ◆ Low 7.7mA (typ) Operating Supply Current*
- ◆ Uses Small, Low-Cost Crystal
- ◆ Small 3mm x 3mm 8-Pin SOT23 Package
- ◆ Fast-On Oscillator: 250μs Startup Time

* At 50% duty cycle (315MHz, 2.7V supply, +13dBm output power)

Ordering Information

PART	TEMP RANGE	PIN-PACKAGE	TOP MARK
MAX7044AKA+T	-40°C to +125°C	8 SOT23	AEJW

+ Denotes a lead(Pb)-free/RoHS-compliant package.

T = Tape and reel.

Pin Configuration

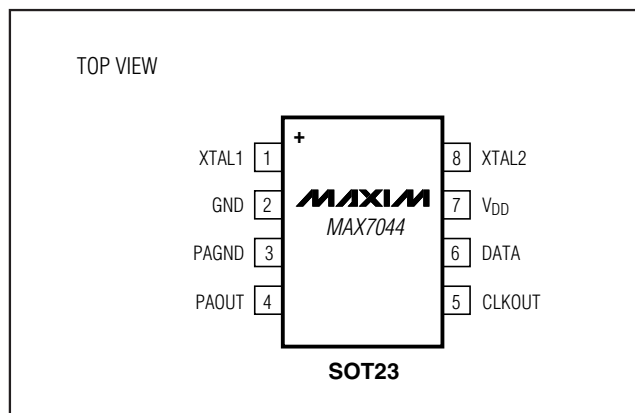

MAXIM

Maxim Integrated Products 1

For pricing, delivery, and ordering information, please contact Maxim Direct at 1-888-629-4642, or visit Maxim's website at www.maxim-ic.com.

MAX7044

300MHz to 450MHz High-Efficiency, Crystal-Based +13dBm ASK Transmitter

ABSOLUTE MAXIMUM RATINGS

V_{DD} to GND-0.3V to +4.0V
 All Other Pins to GND-0.3V to (V_{DD} + 0.3V)
 Continuous Power Dissipation (T_A = +70°C)
 8-Pin SOT23 (derate 8.9mW/°C above +70°C).....714mW
 Operating Temperature Range-40°C to +125°C

Storage Temperature Range-60°C to +150°C
 Junction Temperature+150°C
 Lead Temperature (soldering, 10s)+300°C
 Soldering Temperature (reflow)+260°C

Stresses beyond those listed under "Absolute Maximum Ratings" may cause permanent damage to the device. These are stress ratings only, and functional operation of the device at these or any other conditions beyond those indicated in the operational sections of the specifications is not implied. Exposure to absolute maximum rating conditions for extended periods may affect device reliability.

ELECTRICAL CHARACTERISTICS

(Typical Application Circuit, all RF inputs and outputs are referenced to 50Ω, V_{DD} = +2.1V to +3.6V, T_A = -40°C to +125°C, unless otherwise noted. Typical values are at V_{DD} = +2.7V, T_A = +25°C, unless otherwise noted.) (Note 1)

PARAMETER	SYMBOL	CONDITIONS		MIN	TYP	MAX	UNITS
SYSTEM PERFORMANCE							
Supply Voltage	V _{DD}			2.1		3.6	V
Supply Current (Note 2)	I _{DD}	f _{RF} = 315MHz	V _{DATA} at 50% duty cycle, (Notes 3, 4)		7.7	14.1	mA
			PA on (Note 5)		13.8	25.4	
			PA off (Note 6)		1.7	2.8	
		f _{RF} = 433MHz	V _{DATA} at 50% duty cycle, (Notes 3, 4)		8.0	14.4	
			PA on (Note 5)		14.0	25.7	
			PA off (Note 6)		1.9	3.1	
Standby Current	I _{STDBY}	V _{DATA} < V _{IL} for more than WAIT time (Notes 4, 7)	T _A < +25°C		40	130	nA
			T _A < +125°C		550	2900	
Frequency Range (Note 4)	f _{RF}			300		450	MHz
Data Rate (Note 4)				0		100	kbps
Modulation Depth (Note 8)		ON to OFF P _{OUT} ratio			90		dB
Output Power, PA On (Notes 4, 5)	P _{OUT}	f _{RF} = 300MHz to 450MHz	T _A = +25°C, V _{DD} = +2.7V	9.6	12.5	15.4	dBm
			T _A = +125°C, V _{DD} = +2.1V	5.9	9.0	12.0	
			T _A = -40°C, V _{DD} = +3.6V	13.1	15.8	18.5	
Turn-On Time	t _{ON}	Oscillator settled to within 50kHz			220		μs
		Oscillator settled to within 5kHz			450		
Transmit Efficiency with CW (Notes 5, 9)		f _{RF} = 315MHz			48		%
		f _{RF} = 433MHz			47		
Transmit Efficiency with 50% OOK (Notes 3, 9)		f _{RF} = 315MHz			43		%
		f _{RF} = 433MHz			41		

300MHz to 450MHz High-Efficiency, Crystal-Based +13dBm ASK Transmitter

MAX7044

ELECTRICAL CHARACTERISTICS (continued)

(Typical Application Circuit, all RF inputs and outputs are referenced to 50Ω, V_{DD} = +2.1V to +3.6V, T_A = -40°C to +125°C, unless otherwise noted. Typical values are at V_{DD} = +2.7V, T_A = +25°C, unless otherwise noted.) (Note 1)

PARAMETER	SYMBOL	CONDITIONS	MIN	TYP	MAX	UNITS
PHASE-LOCKED LOOP (PLL)						
VCO Gain				330		MHz/V
Phase Noise		f _{RF} = 315MHz	f _{OFFSET} = 100kHz	-84		dBc/Hz
			f _{OFFSET} = 1MHz	-91		
		f _{RF} = 433MHz	f _{OFFSET} = 100kHz	-82		
			f _{OFFSET} = 1MHz	-89		
Maximum Carrier Harmonics		f _{RF} = 315MHz		-50		dBc
		f _{RF} = 433MHz		-50		
Reference Spur		f _{RF} = 315MHz		-74		dBc
		f _{RF} = 433MHz		-80		
Loop Bandwidth				1.6		MHz
Crystal Frequency	f _{XTAL}			f _{RF} /32		MHz
Frequency Pulling by V _{DD}				3		ppm/V
Crystal Load Capacitance				3		pF
DATA INPUT						
Data Input High	V _{IH}			V _{DD} - 0.25		V
Data Input Low	V _{IL}				0.25	V
Maximum Input Current				10		μA
Pulldown Current				10		μA
CLKOUT OUTPUT						
Output Voltage Low	V _{OL}	I _{SINK} = 650μA (Note 4)			0.25	V
Output Voltage High	V _{OH}	I _{SOURCE} = 350μA (Note 4)		V _{DD} - 0.25		V
Load Capacitance	C _{LOAD}	(Note 4)			10	pF
CLKOUT Frequency				f _{XTAL} /16		Hz

Note 1: Supply current, output power, and efficiency are greatly dependent on board layout and PAOUT match.

Note 2: Production tested at T_A = +25°C with f_{RF} = 300MHz and 450MHz. Guaranteed by design and characterization over temperature and frequency.

Note 3: 50% duty cycle at 10kbps with Manchester coding.

Note 4: Guaranteed by design and characterization, not production tested.

Note 5: PA output is turned on in test mode by V_{DATA} = V_{DD}/2 + 100mV.

Note 6: PA output is turned off in test mode by V_{DATA} = V_{DD}/2 - 100mV.

Note 7: Wait time: t_{WAIT} = (2¹⁶ × 32)/f_{RF}.

Note 8: Generally limited by PCB layout.

Note 9: V_{DATA} = V_{IH}. Efficiency = P_{OUT}/(V_{DD} × I_{DD}).

300MHz to 450MHz High-Efficiency, Crystal-Based +13dBm ASK Transmitter

Typical Operating Characteristics

(Typical Application Circuit, $V_{DD} = +2.7V$, $T_A = +25^\circ C$, unless otherwise noted.) (Note 1)

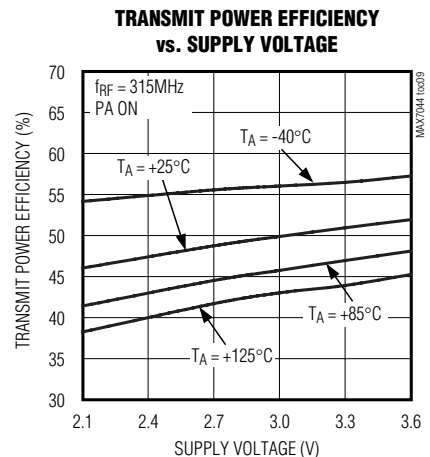
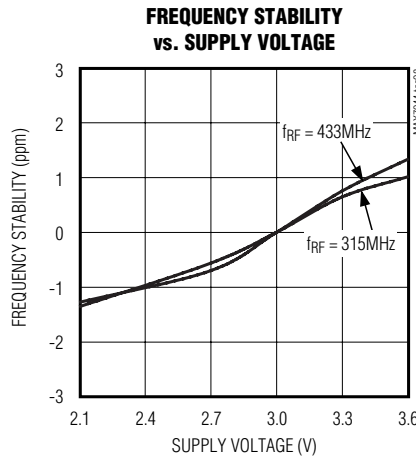
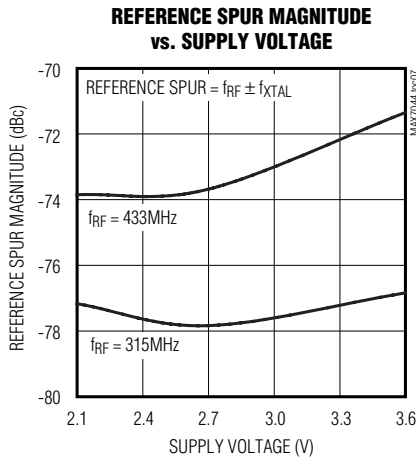
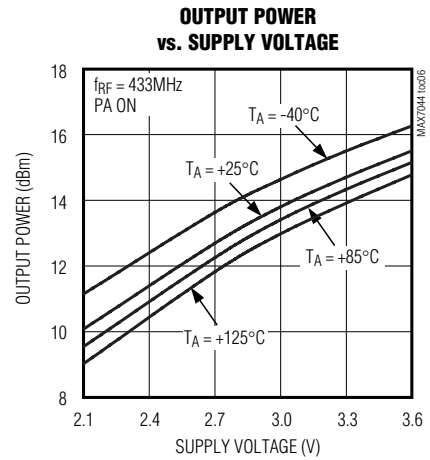
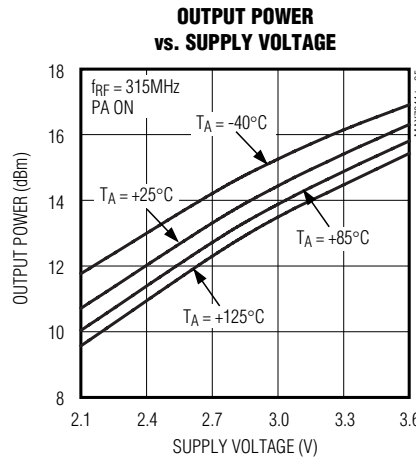
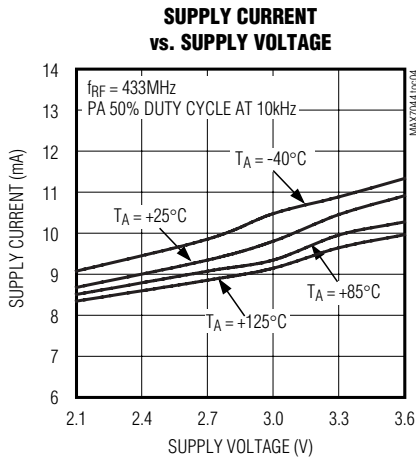
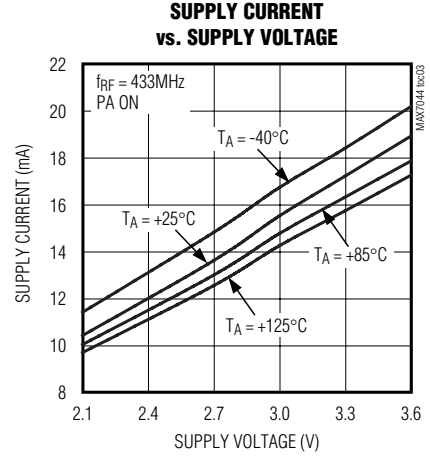
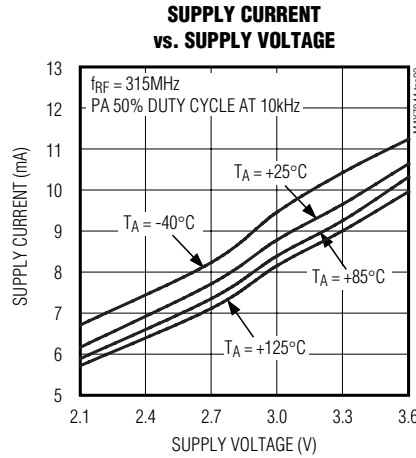
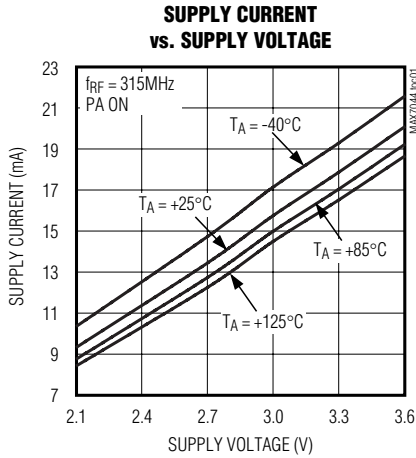

300MHz to 450MHz High-Efficiency, Crystal-Based +13dBm ASK Transmitter

MAX7044

Typical Operating Characteristics (continued)

(Typical Application Circuit, $V_{DD} = +2.7V$, $T_A = +25^\circ C$, unless otherwise noted.) (Note 1)

TRANSMIT POWER EFFICIENCY vs. SUPPLY VOLTAGE

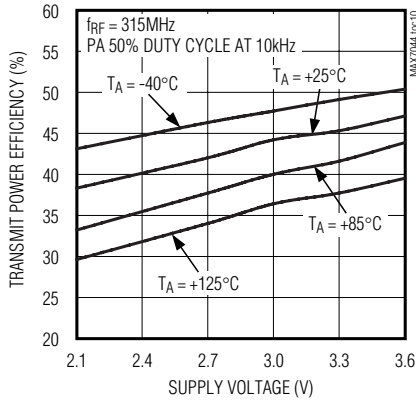

TRANSMIT POWER EFFICIENCY vs. SUPPLY VOLTAGE

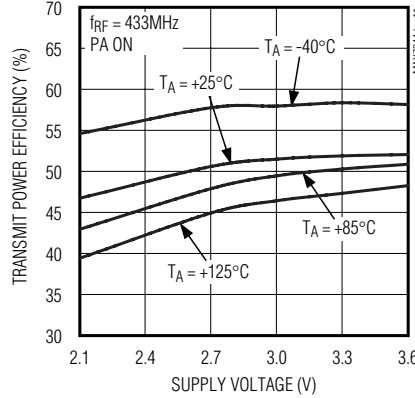

TRANSMIT POWER EFFICIENCY vs. SUPPLY VOLTAGE

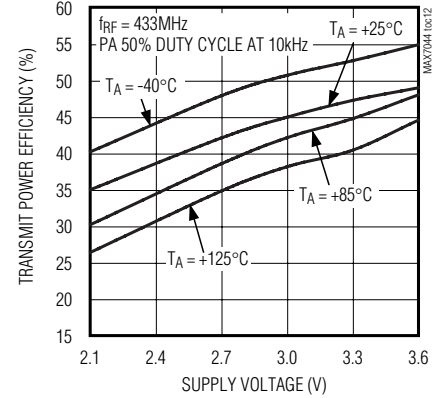

PHASE NOISE vs. OFFSET FREQUENCY

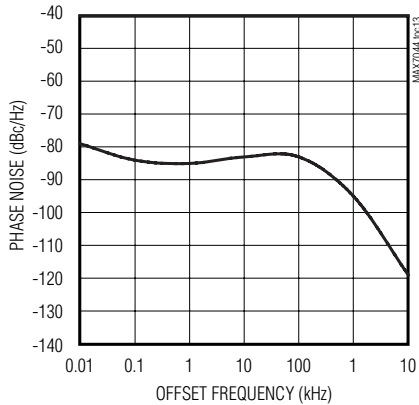

SUPPLY CURRENT AND OUTPUT POWER vs. EXTERNAL RESISTOR

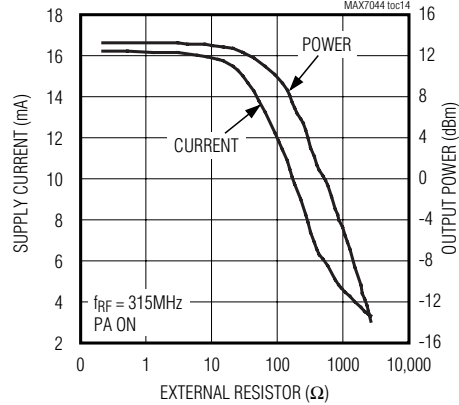

SUPPLY CURRENT vs. OUTPUT POWER

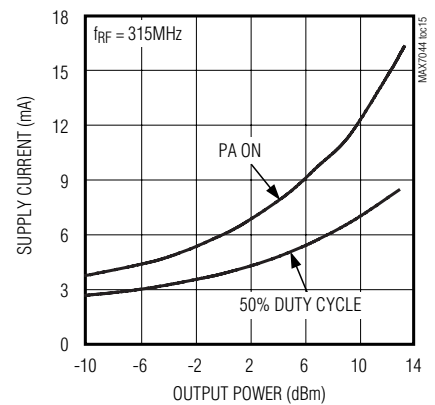

FREQUENCY SETTLING TIME

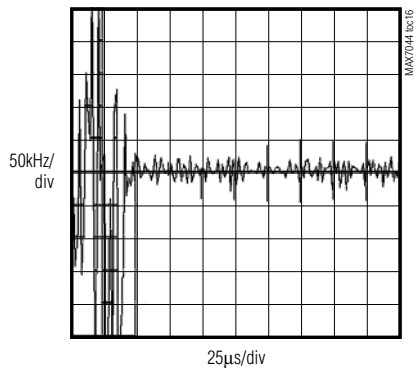

AM DEMODULATION OF PA OUTPUT DATA RATE = 100kHz

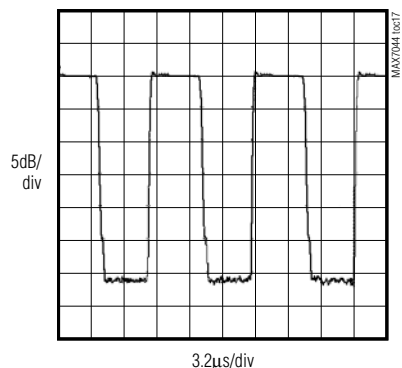

OUTPUT SPECTRUM

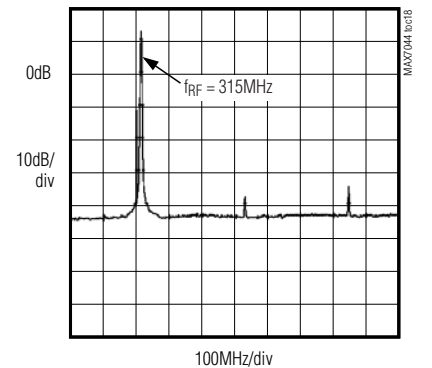

300MHz to 450MHz High-Efficiency, Crystal-Based +13dBm ASK Transmitter

Typical Operating Characteristics (continued)

(Typical Application Circuit, $V_{DD} = +2.7V$, $T_A = +25^\circ C$, unless otherwise noted.) (Note 1)

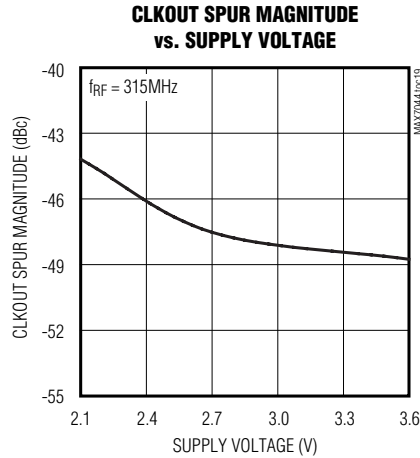

Pin Description

PIN	NAME	FUNCTION
1	XTAL1	1st Crystal Input. $f_{XTAL} = f_{RF}/32$.
2	GND	Ground. Connect to system ground.
3	PAGND	Ground for the Power Amplifier (PA). Connect to system ground.
4	PAOUT	Power-Amplifier Output. The PA output requires a pullup inductor to the supply voltage, which can be part of the output-matching network to an antenna.
5	CLKOUT	Buffered Clock Output. The frequency of CLKOUT is $f_{XTAL}/16$.
6	DATA	OOK Data Input. DATA also controls the power-up state (see the <i>Shutdown Mode</i> section).
7	V_{DD}	Supply Voltage. Bypass to GND with a 100nF capacitor as close to the pin as possible.
8	XTAL2	2nd Crystal Input. $f_{XTAL} = f_{RF}/32$.

Functional Diagram

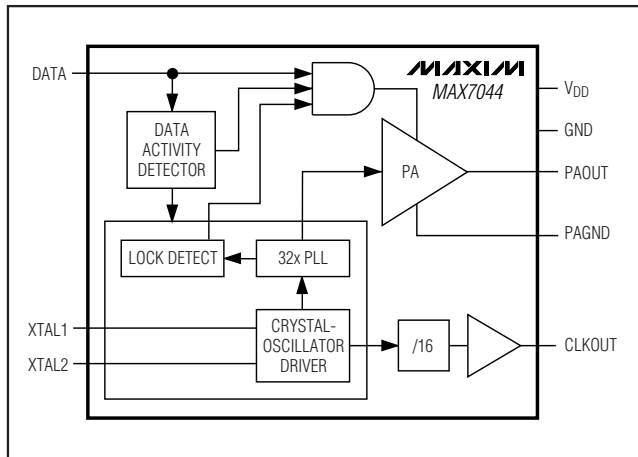

Detailed Description

The MAX7044 is a highly integrated ASK transmitter operating over the 300MHz to 450MHz frequency band. The IC requires only a few external components to complete a transmit solution. The MAX7044 includes a complete PLL and a highly efficient power amplifier. The device is automatically placed into a low-power shutdown mode and powers up when data is detected on the data input.

Shutdown Mode

The MAX7044 has an automatic shutdown mode that places the device in low-power mode if the DATA input has not toggled for a specific amount of time (wait time).

The wait time is equal to 2^{16} clock cycles of the crystal. This equates to a wait time of approximately 6.66ms for a 315MHz RF frequency and 4.84ms for a 433MHz RF

300MHz to 450MHz High-Efficiency, Crystal-Based +13dBm ASK Transmitter

frequency. For other frequencies, calculate the wait time with the following equation:

$$t_{\text{WAIT}} = \frac{2^{16} \times 32}{f_{\text{RF}}}$$

where t_{WAIT} is the wait time to shutdown and f_{RF} is the RF transmit frequency.

When the device is in shutdown, a rising edge on DATA initiates the warm up of the crystal and PLL. The crystal and PLL must have 220 μ s settling time before data can be transmitted. The 220 μ s turn-on time of the MAX7044 is dominated by the crystal oscillator startup time. Once the oscillator is running, the 1.6MHz PLL loop bandwidth allows fast frequency recovery during power amplifier toggling.

When the device is operating, each edge on the data line resets an internal counter to zero and it begins to count again. If no edges are detected on the data line, the counter reaches the end-of-count (2^{16} clock cycles) and places the device in shutdown mode. If there is an edge on the data line before the counter hits the end of count, the counter is reset and the process starts over. It may be necessary to keep the power amplifier on steadily for testing and debugging purposes. To do this, set the DATA pin voltage slightly above the midpoint between V_{DD} and ground ($V_{\text{DD}}/2 + 100\text{mV}$).

Phase-Locked Loop

The PLL block contains a phase detector, charge pump, integrated loop filter, VCO, asynchronous 32x clock divider, and crystal oscillator. This PLL requires no external components. The relationship between the carrier and crystal frequency is given by:

$$f_{\text{XTAL}} = f_{\text{RF}}/32$$

The lock-detect circuit prevents the power amplifier from transmitting until the PLL is locked. In addition, the device shuts down the power amplifier if the reference frequency is lost.

Power Amplifier (PA)

The PA of the MAX7044 is a high-efficiency, open-drain, switch-mode amplifier. With a proper output matching network, the PA can drive a wide range of impedances, including the small-loop PCB trace antenna and any 50 Ω antenna. The output-matching network for an antenna with a characteristic impedance of 50 Ω is shown in the *Typical Application Circuit*. The output-matching network suppresses the carrier harmonics and transforms the antenna impedance to an optimal impedance at PAOUT, which is about 125 Ω .

When the output matching network is properly tuned, the power amplifier transmits power with high efficiency.

The *Typical Application Circuit* delivers +13dBm at +2.7V supply with 7.7mA of supply current. Thus, the overall efficiency is 48% with the efficiency of the power amplifier itself greater than 54%.

Buffered Clock Output

The MAX7044 provides a buffered clock output (CLKOUT) for easy interface to a microcontroller or frequency-hopping generator. The frequency of CLKOUT is 1/16 the crystal frequency. For a 315MHz RF transmit frequency, a crystal of 9.84375MHz is used, giving a clock output of 615.2kHz. For a 433.92MHz RF frequency, a crystal of 13.56MHz is used for a clock output of 847.5kHz.

The clock output is inactive when the device is in shutdown mode. The device is placed in shutdown mode by the internal data activity detector (see the *Shutdown Mode* section). Once data is detected on the data input, the clock output is stable after approximately 220 μ s.

Applications Information

Output Power Adjustment

It is possible to adjust the output power down to -15dBm with the addition of a resistor (see RPWRADJ in Figure 1). The addition of the power adjust resistor also reduces power consumption. See the Supply Current and Output Power vs. External Resistor and Supply Current vs. Output Power graphs in the *Typical Operating Characteristics* section. It is imperative to add both a low-frequency and a high-frequency decoupling capacitor as shown in Figure 1.

Crystal Oscillator

The crystal oscillator in the MAX7044 is designed to present a capacitance of approximately 3pF between the XTAL1 and XTAL2 pins. If a crystal designed to

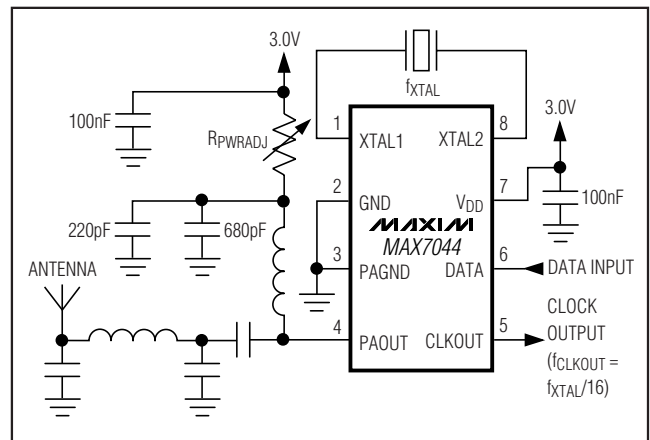

Figure 1. Output Power Adjustment Circuit

300MHz to 450MHz High-Efficiency, Crystal-Based +13dBm ASK Transmitter

oscillate with a different load capacitance is used, the crystal is pulled away from its intended operating frequency, thus introducing an error in the reference frequency. Crystals designed to operate with higher differential load capacitance always pull the reference frequency higher. For example, a 9.84375MHz crystal designed to operate with a 10pF load capacitance oscillates at 9.84688MHz with the MAX7044, causing the transmitter to be transmitting at 315.1MHz rather than 315.0MHz, an error of about 100kHz, or 320ppm.

In actuality, the oscillator pulls every crystal. The crystal's natural frequency is really below its specified frequency, but when loaded with the specified load capacitance, the crystal is pulled and oscillates at its specified frequency. This pulling is already accounted for in the specification of the load capacitance. Additional pulling can be calculated if the electrical parameters of the crystal are known. The frequency pulling is given by:

$$f_p = \frac{C_m}{2} \left(\frac{1}{C_{\text{case}} + C_{\text{load}}} - \frac{1}{C_{\text{case}} + C_{\text{spec}}} \right) \times 10^6$$

where:

f_p is the amount the crystal frequency is pulled in ppm.

C_m is the motional capacitance of the crystal.

C_{case} (or C_o) is the vendor-specified case capacitance of the crystal.

C_{spec} is the specified load capacitance.

C_{load} is the actual load capacitance.

When the crystal is loaded as specified, i.e., $C_{\text{load}} = C_{\text{spec}}$, the frequency pulling equals zero.

Output Matching to 50Ω

When matched to a 50Ω system, the MAX7044 PA is capable of delivering up to +13dBm of output power at $V_{DD} = 2.7V$. The output of the PA is an open-drain transistor that requires external impedance matching and pullup inductance for proper biasing. The pullup inductance from PA to V_{DD} serves three main purposes: it resonates the capacitance of the PA output, provides biasing for the PA, and becomes a high-frequency choke to reduce the RF energy coupling into V_{DD} . The recommended output-matching network topology is shown in the *Typical Application Circuit*. The matching network transforms the 50Ω load to approximately 125Ω at the output of the PA in addition to forming a bandpass filter that provides attenuation for the higher order harmonics.

Output Matching to PCB Loop Antenna

In some applications, the MAX7044 power amplifier output has to be impedance matched to a small-loop antenna. The antenna is usually fabricated out of a copper trace on a PCB in a rectangular, circular, or square pattern. The antenna will have an impedance that consists of a lossy component and a radiative component. To achieve high radiating efficiency, the radiative component should be as high as possible, while minimizing the lossy component. In addition, the loop antenna will have an inherent loop inductance associated with it (assuming the antenna is terminated to ground). For example, in a typical application, the radiative impedance is less than 0.5Ω, the lossy impedance is less than 0.7Ω, and the inductance is approximately 50nH to 100nH.

The objective of the matching network is to match the power amplifier output to the small-loop antenna. The matching components thus transform the low radiative and resistive parts of the antenna into the much higher value of the PA output. This gives higher efficiency. The low radiative and lossy components of the small-loop antenna result in a higher Q matching network than the 50Ω network; thus, the harmonics are lower.

Layout Considerations

A properly designed PCB is an essential part of any RF/microwave circuit. At the power amplifier output, use controlled-impedance lines and keep them as short as possible to minimize losses and radiation. At high frequencies, trace lengths that are approximately 1/20 the wavelength or longer become antennas. For example, a 2in trace at 315MHz can act as an antenna.

Keeping the traces short also reduces parasitic inductance. Generally, 1in of PCB trace adds about 20nH of parasitic inductance. The parasitic inductance can have a dramatic effect on the effective inductance. For example, a 0.5in trace connecting a 100nH inductor adds an extra 10nH of inductance, or 10%.

To reduce the parasitic inductance, use wider traces and a solid ground or power plane below the signal traces. Using a solid ground plane can reduce the parasitic inductance from approximately 20nH/in to 7nH/in. Also, use low-inductance connections to ground on all GND pins, and place decoupling capacitors close to all V_{DD} connections.

300MHz to 450MHz High-Efficiency, Crystal-Based +13dBm ASK Transmitter

Chip Information

PROCESS: CMOS

Package Information

For the latest package outline information and land patterns (footprints), go to www.maxim-ic.com/packages. Note that a "+", "#", or "-" in the package code indicates RoHS status only. Package drawings may show a different suffix character, but the drawing pertains to the package regardless of RoHS status.

PACKAGE TYPE	PACKAGE CODE	OUTLINE NO.	LAND PATTERN NO.
8 SOT23	K8SN+1	21-0078	90-0176

MAX7044

300MHz to 450MHz High-Efficiency, Crystal-Based +13dBm ASK Transmitter

Revision History

REVISION NUMBER	REVISION DATE	DESCRIPTION	PAGES CHANGED
3	6/09	Changed part number in <i>Ordering Information</i> to lead-free and made a correction in the <i>Power Amplifier (PA)</i> section	1, 7
4	2/11	Deleted Maximum Crystal Inductance spec and Note 9 from the <i>Electrical Characteristics</i> table and updated the <i>Absolute Maximum Ratings, Shutdown Mode</i> , and <i>Crystal Oscillator</i> sections	2, 3, 7, 8

Maxim cannot assume responsibility for use of any circuitry other than circuitry entirely embodied in a Maxim product. No circuit patent licenses are implied. Maxim reserves the right to change the circuitry and specifications without notice at any time.

10 _____ **Maxim Integrated Products, 120 San Gabriel Drive, Sunnyvale, CA 94086 408-737-7600**